

Diffusion



VEF overall dimensions

DN	A	B	C	F
100	100	70	145	55
150	150	115	195	55
200	200	172	240	55

KKC overall dimensions

DN	A	B	C	F
100	138	75	40	97.5
150	202	119	50	147.5
200	248	157	63	197.5

SF-S overall dimensions

DN	ØD [mm]	Ød [mm]	A [mm]
100	135	100	15
160	191	160	15
200	238	200	18

Description

KKC: ventilation valves with adjustable disc and fastening collar
 • made of aluminium with RAL 9010 finish

VEF: ventilation valves with adjustable disc and fastening collar
 • made of PVC, white

SF-S: adjustable ventilation valves, suitable for air supply and return, including acoustic insert
 • made of aluminium with RAL 9010 finish

Special versions

- made of 304/316 stainless steel (on request)
- VR: coating according to the RAL table (on request)

VEF

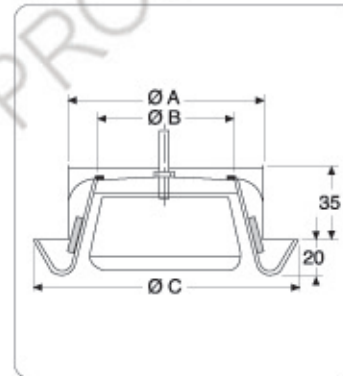

KKC

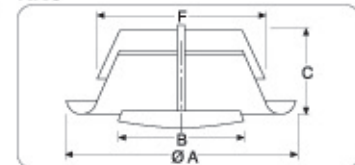

SF-S

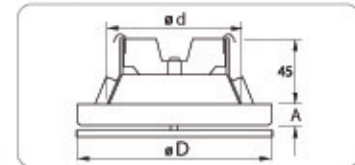

KKC / VEF selection diagrams DN 100

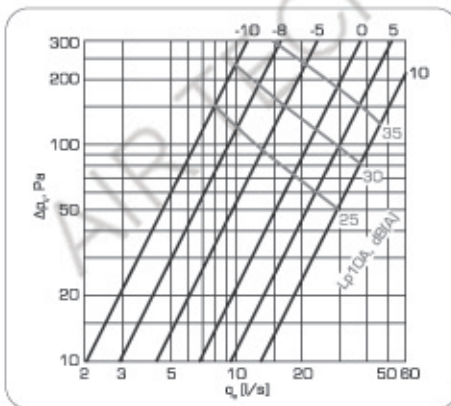

DN 150

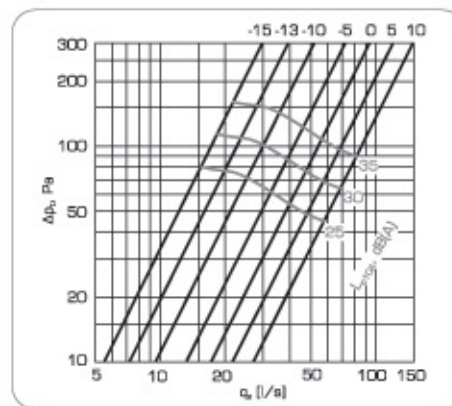

DN 200

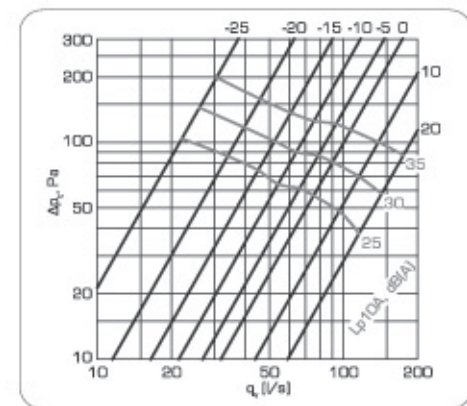

SF-S selection diagrams DN 100

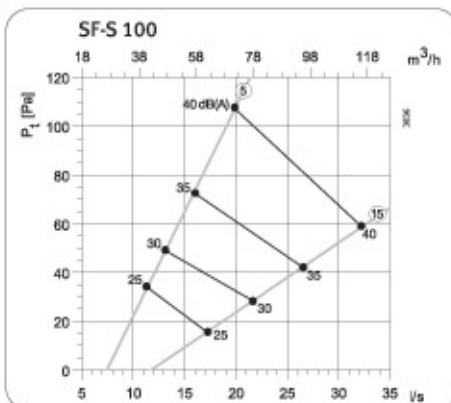

DN 160

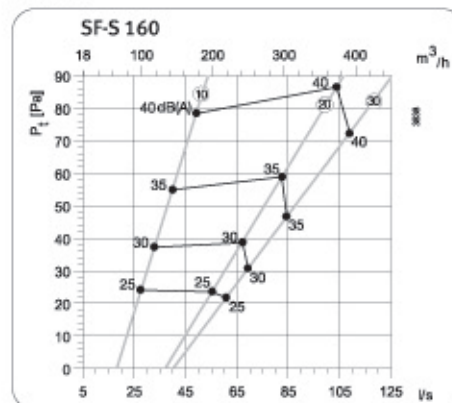

DN 200

